

8

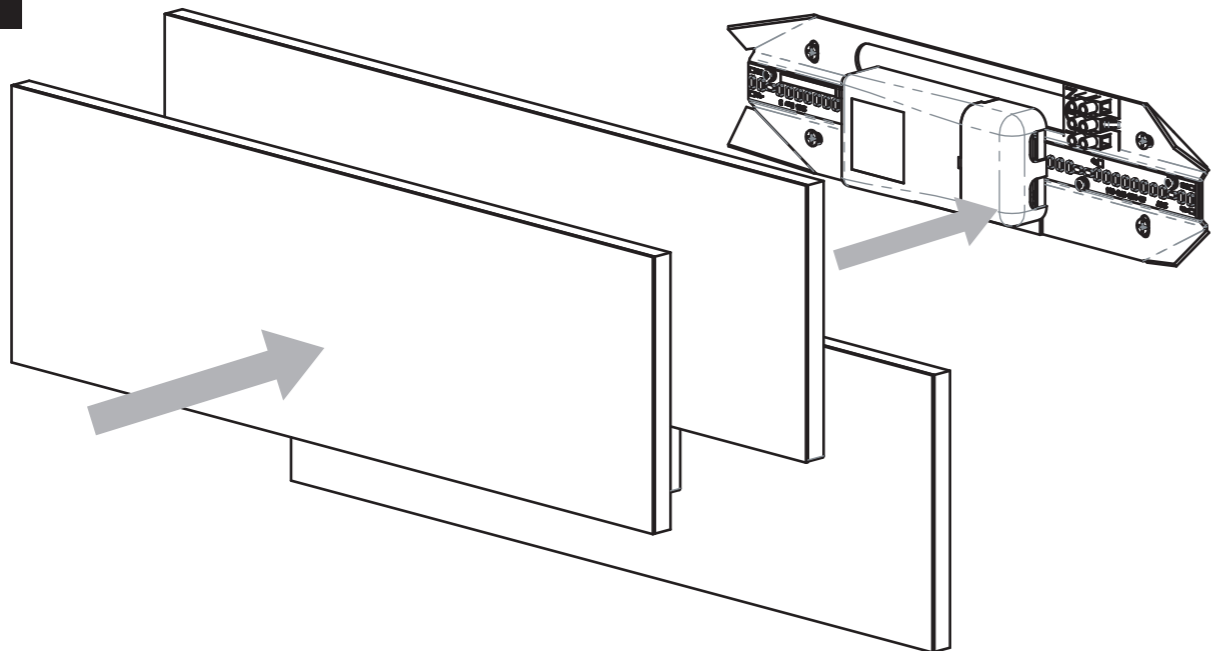

9

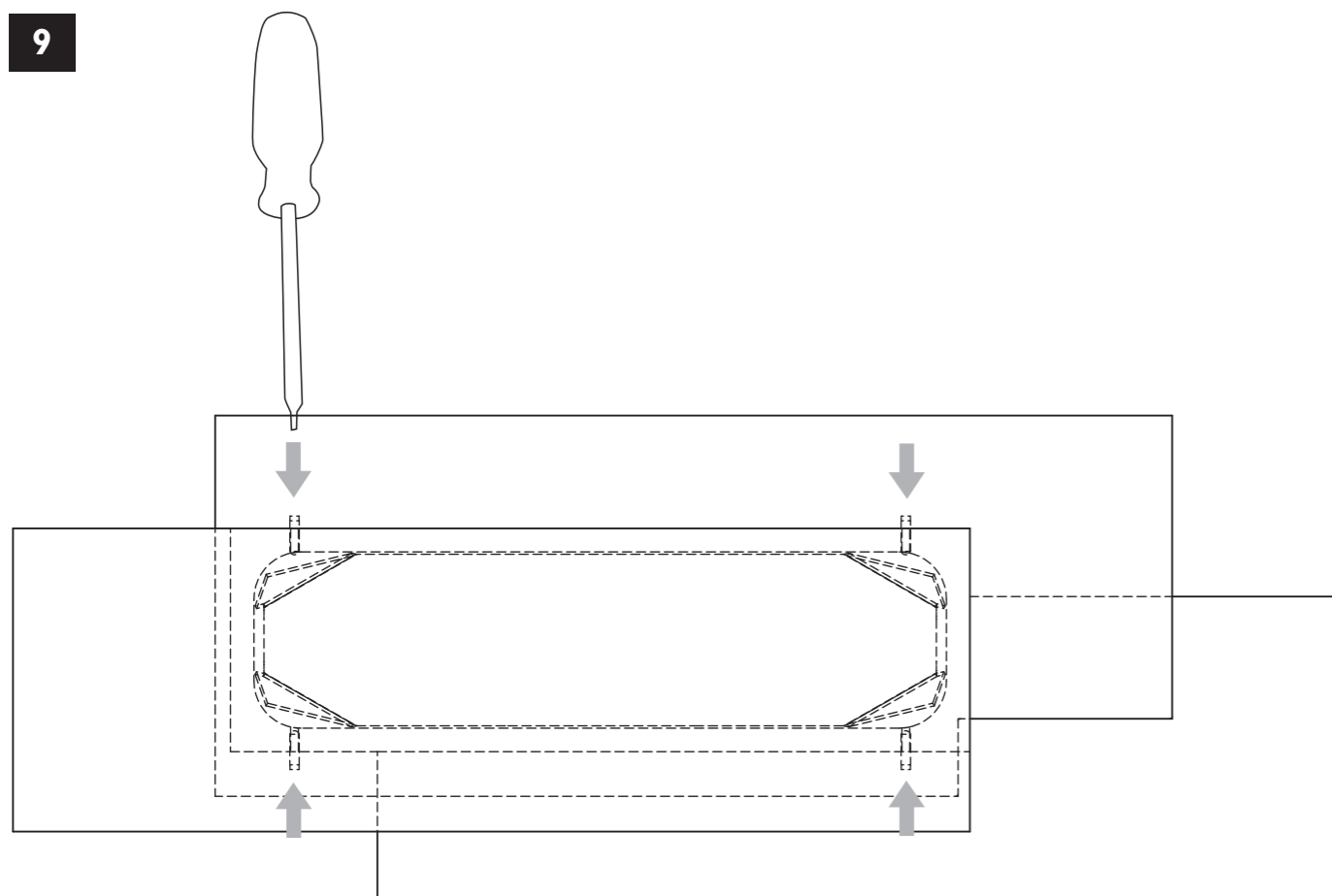

Edge 560

7385

■ astro

GB

Products with electronic ballasts must not be installed on the same electrical circuits as products with inductive loads, for example magnetic fluorescent luminaires, motors or ventilators. Inductive loads can generate excessive voltage surges which can damage electronic ballasts.

F

Les luminaires utilisant un ballast électronique ne peuvent être installés sur le même circuit que des appareils avec charges inductives, tels que luminaires fluorescents magnétiques, moteurs et ventilateurs. Les charges inductives peuvent générer des voltages excessifs et ainsi endommager les ballasts électroniques.

E

Los productos con reactancias electrónicas no deben ser instalados en los mismos circuitos eléctricos que los productos con carga inductiva como, por ejemplo, luminarias de fluorescentes magnéticos, motores o ventiladores. La carga inductiva puede generar sobrevoltajes excesivos que podrían dañar las reactancias electrónicas.

D

Produkte mit elektronischem Vorschaltgerät dürfen nicht an die gleichen Stromkreise angeschlossen werden wie Produkte mit induktiver Ladung, wie z.B. magnetische Neonleuchten, Motoren oder Ventilatoren. Induktive Ladung kann Stromstöße hervorrufen, die elektronischen Vorschaltgeräte beschädigen können.

GB

Please read the instructions carefully before commencing assembly

Live : Normally Brown / Red
Neutral : Normally Blue / Black
Earth : Normally Green / Yellow

F

Lire attentivement les instructions avant de commencer le montage

Phase : Normalement Brun / Rouge
Neutre : Normalement Bleu / Noir
Terre : Normalement Vert / Jaune

E

Leer atentamente las instrucciones antes de comenzar el montaje

Fase : Normalmente Marro / Rojo
Neutro : Normalmente Azul / Negro
Tierra : Normalmente Verde / Amarillo

D

Lesen Sie bitte die Anweisungen sorgfältig durch, bevor Sie mit dem Zusammenbauen beginnen

Phase : Normalerweise Braun / Rot
Nulleiter : Normalerweise Blau / Schwarz
Erde : Normalerweise Grün / Gelb

1

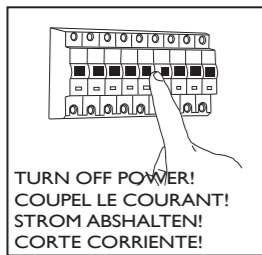

2

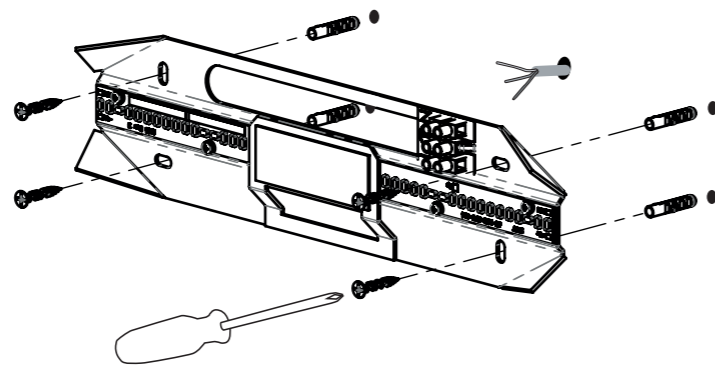

3

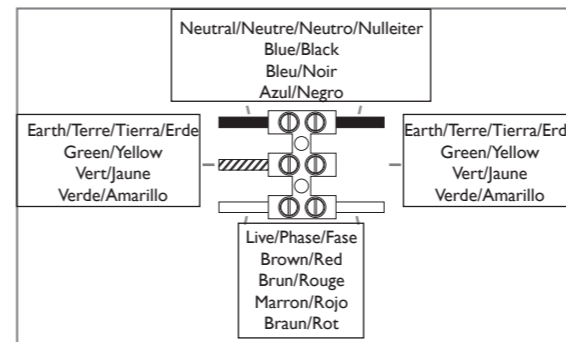

4

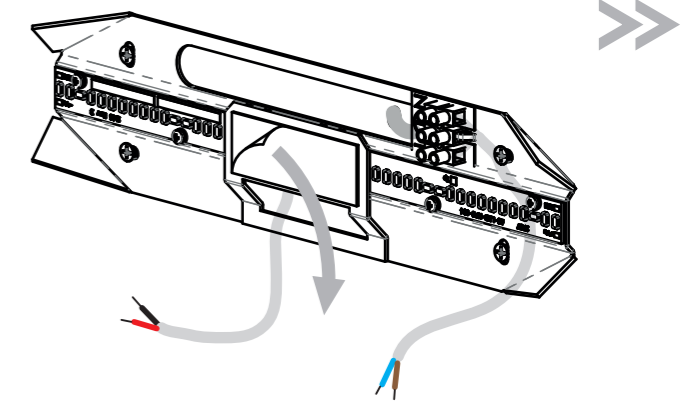

LED DRIVERS

Use **only**:

1831

Non-dimmable, 220-240V 50/60Hz

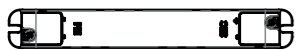

5

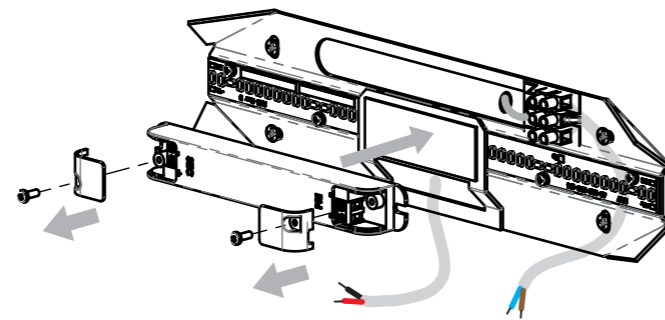

6

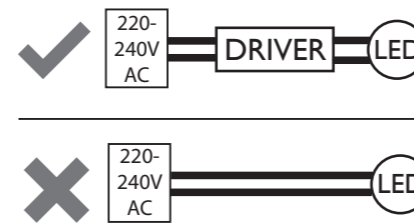

7

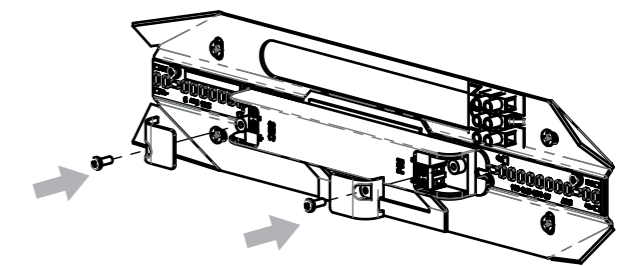

1832

Leading and trailing edge dimmable, 220-240V 50/60Hz

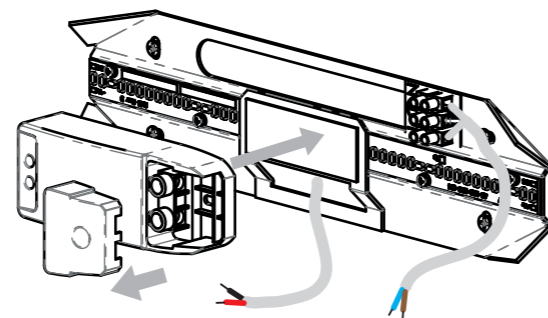

Do not connect LED directly to mains supply. Driver must be used. Follow wiring instructions supplied with LED driver.



Ne pas brancher les LED directement sur le secteur. Uniquement via driver. Veuillez suivre les instructions de câblage fournies avec le LED driver.



Die LED darf nicht direkt an 230V angeschlossen werden. Hierzu wird ein Konverter benötigt. Bitte folgen Sie den Anweisungen für den Kabelanschluss, welche mit dem LED Treiber geliefert werden



Non collegare direttamente alla corrente. Utilizzare il driver. Seguire le istruzioni di montaggio fornite con il driver

1835

I-10V dimmable, 110-240V 50/60Hz

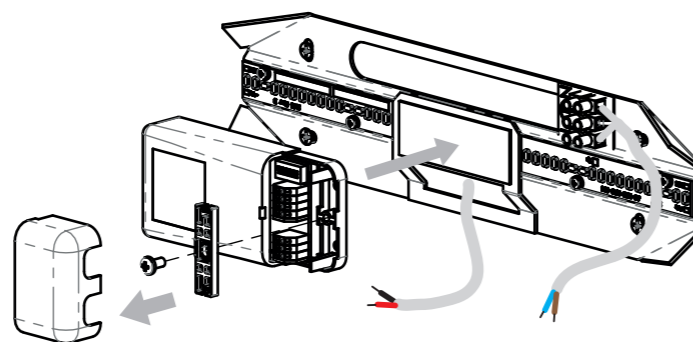
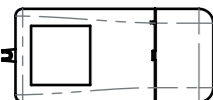

1836

DALI dimmable, 110-240V 50/60Hz

