

GB

PLEASE READ THE INSTRUCTIONS CAREFULLY BEFORE COMMENCING ASSEMBLY

Live: Normally Brown / Red
Neutral: Normally Blue / Black

FR

LIRE ATTENTIVEMENT LES INSTRUCTIONS AVANT DE COMMENCER LE MONTAGE

Phase: Normalement Brun / Rouge
Neutre: Normalement Bleu / Noir

IT

LEGGERE ATTENTAMENTE LE ISTRUZIONI PRIMA DI COMINCIARE L'ASSEMBLAGGIO

Cavo positivo: normalmente marrone o rosso
Cavo neutro: normalmente blu o nero

DE

LESEN SIE BITTE DIE ANWEISUNGEN SORGFÄLTIG DURCH, BEVOR SIE MIT DEM ZUSAMMENBAUEN BEGINNEN

Phase: Normalerweise Braun / Rot
Nulleiter: Normalerweise Blau / Schwarz

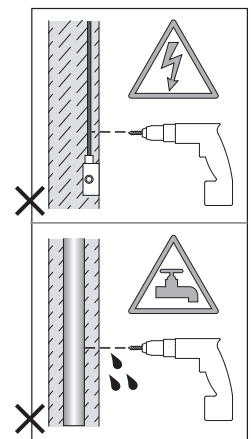

GB If the external cord of this luminaire is damaged, it must be replaced by the manufacturer or a qualified person.

FR Si le câble externe est endommagé, il doit être remplacé par le fabricant ou par une personne agréée.

DE Wenn das externe Netzkabel beschädigt ist, muss es durch den Hersteller oder eine ähnlich qualifizierte Person ersetzt werden.

IT Se il cavo esterno è danneggiato, deve essere sostituito dal costruttore o da personale qualificato.

ESP Si el cable exterior está dañado, debe ser sustituido por el fabricante o una persona cualificada.

SWE Om den externa sladden är skadad måste den bytas ut av tillverkaren eller en kvalificerad person.

POL Uszkodzony przewód zewnętrzny musi wymienić producent lub wykwalifikowana osoba.

FIN Jos ulkoinen johto on vaurioitunut, valmistajan tai pätevän henkilön on vaihdettava se.

Y

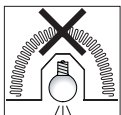

NOT SUITABLE FOR COVERING WITH THERMAL INSULATION.

Ne peut être recouvert de matériaux d'isolation.

Non adatto ad essere coperto da isolanti termici.

Nicht für die Abdeckung mit Wärmedämmung geeignet.



FOR CEILING USE ONLY

Seulement pour montage au plafond

Da utilizzarsi solo al soffitto

Nur für den Deckengebrauch

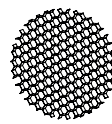
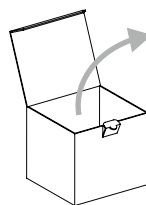
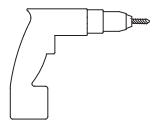
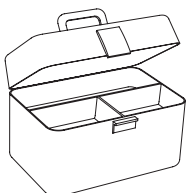

x1

Glare guard

Protection anti-éblouissement

Protezione antiabbagliamento

Antiblendschutz

1

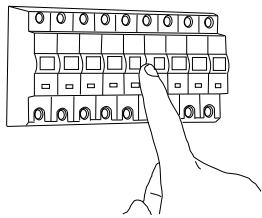

TURN OFF POWER
Couper le courant! /
Spegnere la corrente! /
Strom Abshalten!

2

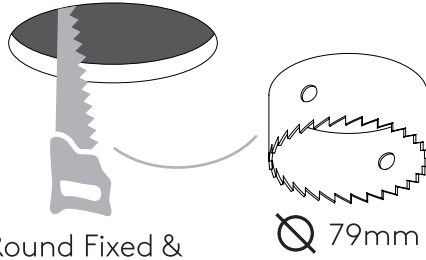

Round Fixed &
Round Adjustable

Ø 79mm

Square Fixed &
Square Adjustable

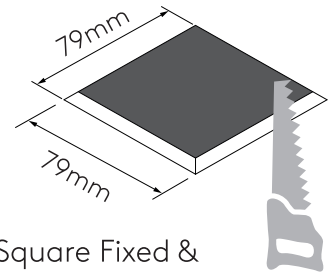

3

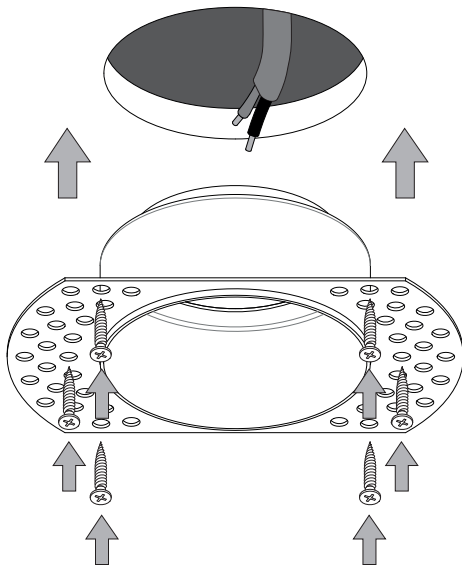

4

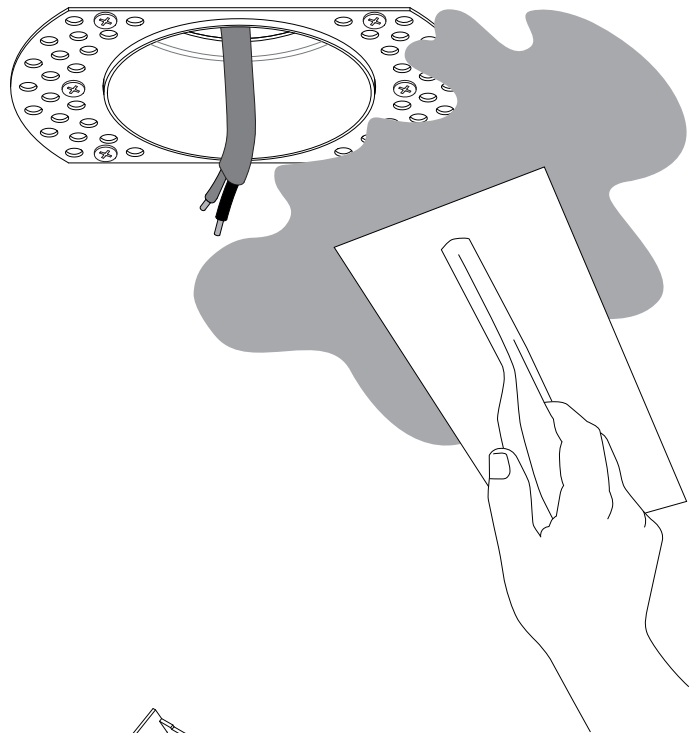

! FIXINGS NOT INCLUDED /
• Fixations non incluses /
Elementi di fissaggio
non inclusi /
Befestigungen
nicht eingeschlossen

5

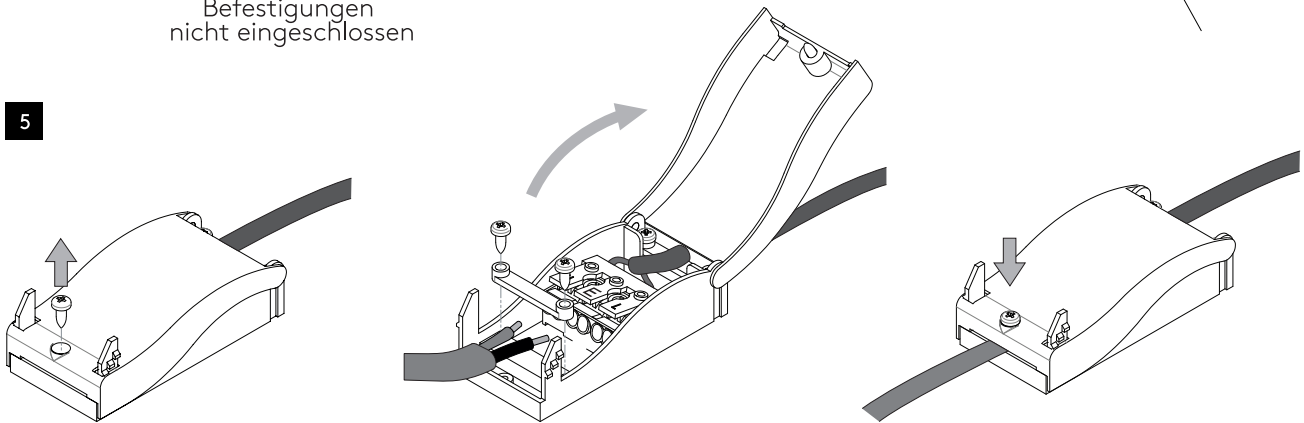

Neutral/Neutre/Neutro/Nulleiter
Blue/Black
Bleu/Noir
Azul/Negro

This terminal is for continuity purposes only /
Ce terminal est uniquement à des fins de continuité /
Questo terminale è solo a scopo di continuità /
Dieses Terminal dient nur zu Durchgangszwecken

Live/Phase/Fase
Brown/Red
Brun/Rouge
Marrón/Rojo
Braun/Rot

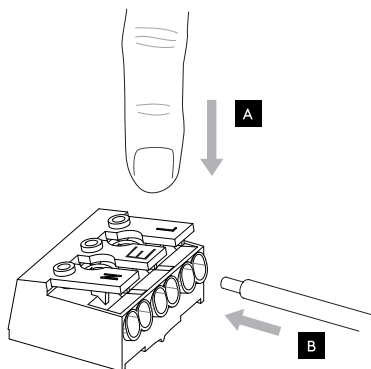

6

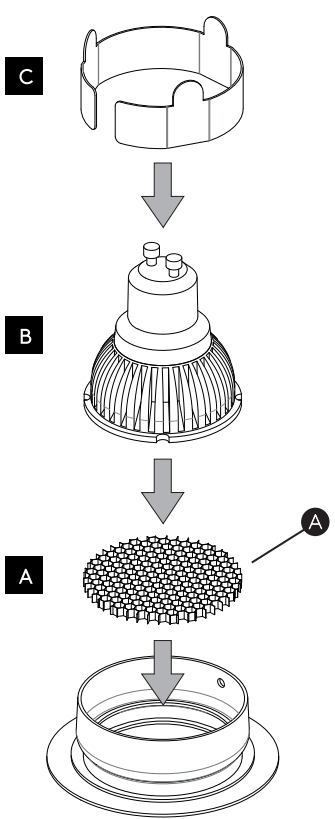

7

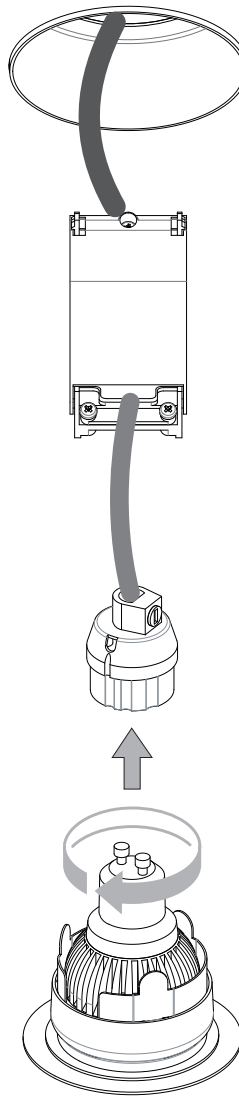

8

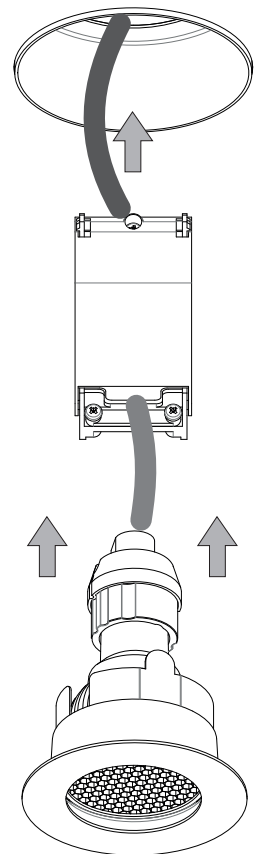

9

