

**GB**

PLEASE READ THE INSTRUCTIONS CAREFULLY BEFORE COMMENCING ASSEMBLY

Live: Normally Brown / Red  
Neutral: Normally Blue / Black  
Earth: Normally Green / Yellow

**FR**

LIRE ATTENTIVEMENT LES INSTRUCTIONS AVANT DE COMMENCER LE MONTAGE

Phase: Normalement Brun / Rouge  
Neutre: Normalement Bleu / Noir  
Terre: Normalement Vert / Jaune

**IT**

LEGGERE ATTENTAMENTE LE ISTRUZIONI PRIMA DI COMINCIARE L'ASSEMBLAGGIO

Cavo positivo: normalmente marrone o rosso  
Cavo neutro: normalmente blu o nero  
Cavo terra: normalmente verde o giallo

**DE**

LESEN SIE BITTE DIE ANWEISUNGEN SORGFALTIG DURCH, BEVOR SIE MIT DEM ZUSAMMENBAUEN BEGINNEN

Phase: Normalerweise Braun / Rot  
Nulleiter: Normalerweise Blau / Schwarz  
Erde: Normalerweise Grün / Gelb

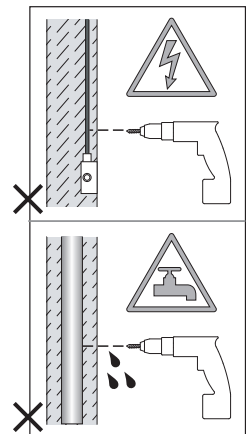

NOT SUITABLE FOR MOUNTING IN FLAMMABLE MATERIALS, E.G. WOOD.

Ne convient pas pour montage dans des matériaux inflammables.  
Non adatto ad essere montato in materiali infiammabili (per esempio legno).  
Nicht geeignet für eine Installation auf brennbaren Materialien, wie z.B. Holz.

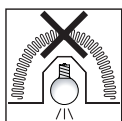

NOT SUITABLE FOR COVERING WITH THERMAL INSULATION.

Ne peut être recouvert de matériaux d'isolation.  
Non adatto ad essere coperto da isolanti termici.  
Nicht für die Abdeckung mit Wärmedämmung geeignet.



FOR CEILING USE ONLY

Seulement pour montage au plafond  
Da utilizzarsi solo al soffitto  
Nur für den Deckengebrauch



ALL ELECTRICAL CONNECTIONS MUST BE FULLY COVERED WITH INSULATING TAPE.

Toutes les connexions électriques doivent être entièrement recouvertes de ruban isolant.  
Alle elektrischen Anschlüsse müssen vollständig mit Isolierband abgedeckt werden.  
Tutte le connessioni elettriche devono essere coperte perfettamente con il nastro isolante.

1

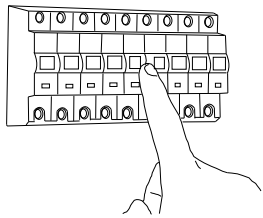

**TURN OFF POWER**  
 Couper Le Courant! / Strom Abhalten!  
 / Corte La Corriente!

2

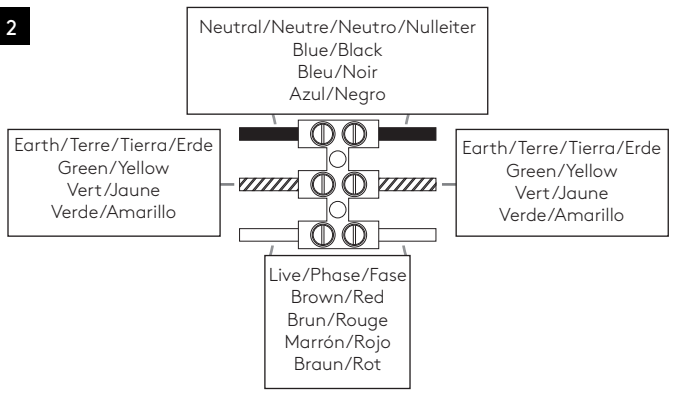

3

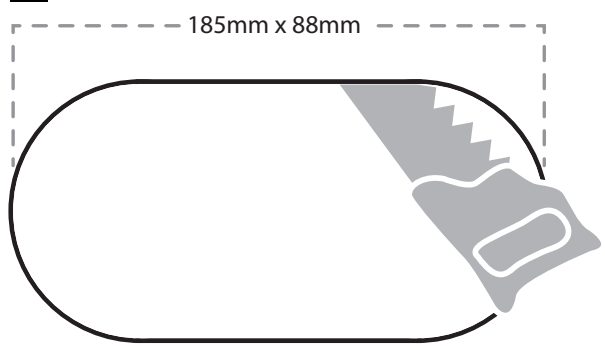

4

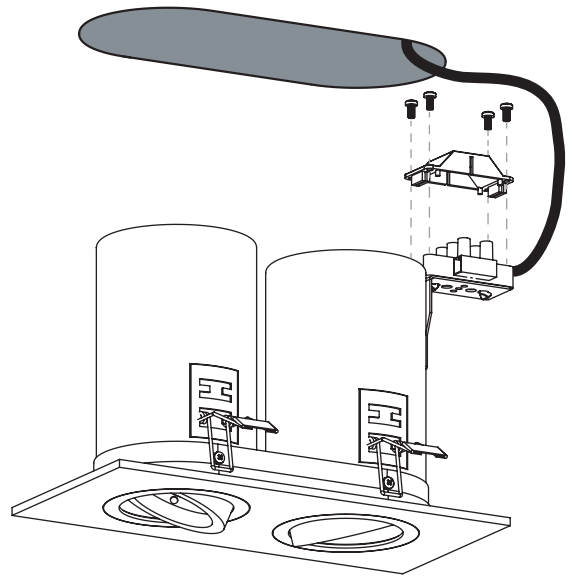

5

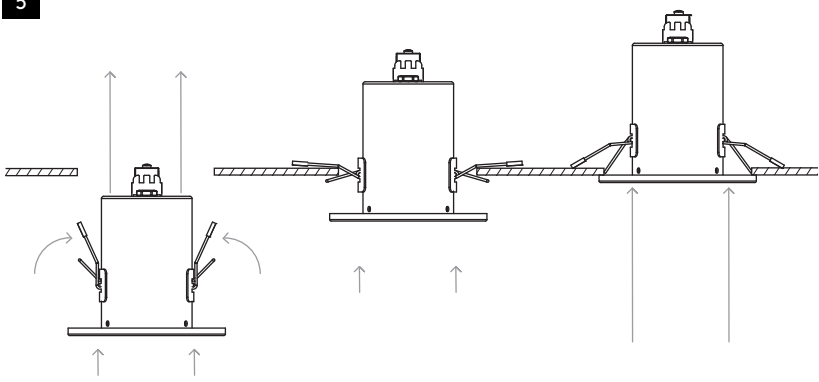

6

