

# CONCRETE OSLO/ DUNBAR 120

astro

**GB** Products with electronic ballasts / drivers must not be installed on the same electrical circuits as products with inductive loads, for example magnetic fluorescent luminaires, motors or ventilators. Inductive loads can generate excessive voltage surges which can damage electronic ballasts.

**FR** Les luminaires utilisant un ballast électronique / drivers ne peuvent être installés sur le même circuit que des appareils avec charges inductives, tels que luminaires fluorescents magnétiques, moteurs et ventilateurs. Les charges inductives peuvent générer des voltages excessifs et ainsi endommager les ballasts électroniques.

**IT** Tutti i prodotti che includono ballast elettronici / driver non devono essere installati sugli stessi circuiti elettrici come anche prodotti con carichi induttivi quali lampadari a fluorescenza magnetica, motori o ventilatori. I carichi induttivi possono generare scariche eccessive che possono danneggiare i ballast.

**DE** Produkte mit elektronischen Vorschaltgeräten/ Treibern dürfen nicht im selben Stromkreislauf installiert werden wie Verbraucher mit induktiven Lasten, z.B. magnetische Leuchtstofflampen, Motoren oder Ventilatoren. Induktive Lasten können übermäßige Spannungsspitzen erzeugen, die elektronische Vorschaltgeräte beschädigen könnten.

**GB**

PLEASE READ THE INSTRUCTIONS CAREFULLY BEFORE COMMENCING ASSEMBLY

Live: Normally Brown / Red  
Neutral: Normally Blue / Black  
Earth: Normally Green / Yellow

**FR**

LIRE ATTENTIVEMENT LES INSTRUCTIONS AVANT DE COMMENCER LE MONTAGE

Phase: Normalement Brun / Rouge  
Neutre: Normalement Bleu / Noir  
Terre: Normalement Vert / Jaune

**IT**

LEGGERE ATTENTAMENTE LE ISTRUZIONI PRIMA DI COMINCIARE L'ASSEMBLAGGIO

Cavo positivo: normalmente marrone o rosso  
Cavo neutro: normalmente blu o nero  
Cavo terra: normalmente verde o giallo

**DE**

LESEN SIE BITTE DIE ANWEISUNGEN SORGFÄLTIG DURCH, BEVOR SIE MIT DEM ZUSAMMENBAUEN BEGINNEN

Phase: Normalerweise Braun / Rot  
Nulleiter: Normalerweise Blau / Schwarz  
Erde: Normalerweise Grün / Gelb

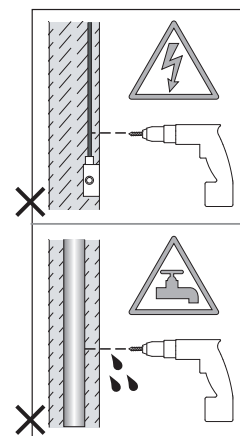

UNSUITABLE FOR DIMMING

Ne convient pour gradateur  
Non dimmerabile  
Nicht zum Dimmen geeignet



FOR WALL USE ONLY  
Usage mural uniquement  
Solo per uso a parete  
Nur zur Verwendung als Wandleuchte



ALL ELECTRICAL CONNECTIONS MUST BE FULLY COVERED WITH INSULATING TAPE.

Toutes les connexions électriques doivent être entièrement recouvertes de ruban isolant.

Alle elektrischen Anschlüsse müssen vollständig mit Isolierband abgedeckt werden.

Tutte le connessioni elettriche devono essere coperte perfettamente con il nastro isolante.

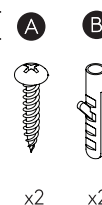
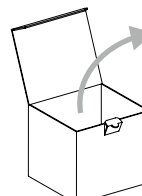
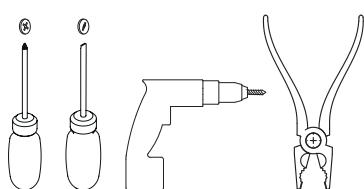
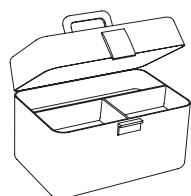

x2

x2

1

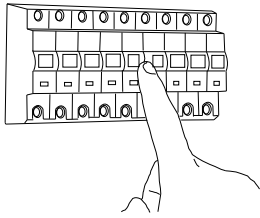

TURN OFF POWER!

Couper Le Courant! / Strom Abshalten!  
/ Corte La Corriente!

2

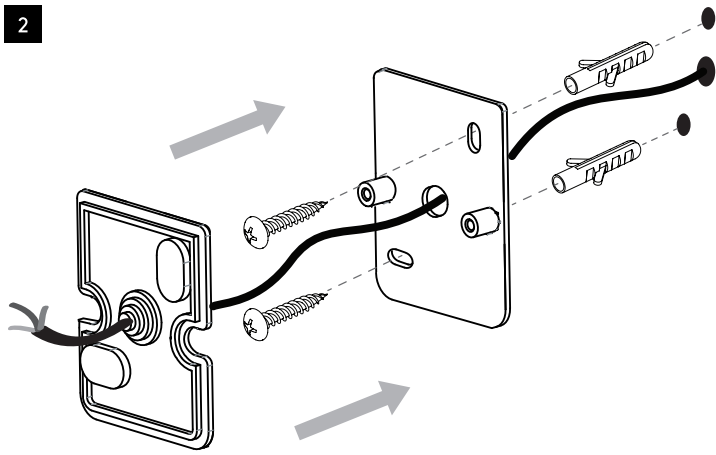

3

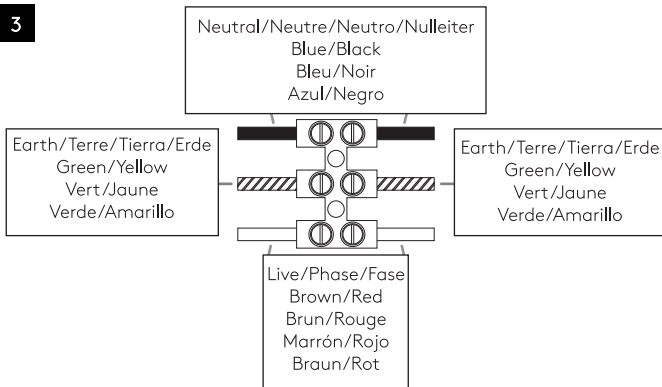

4

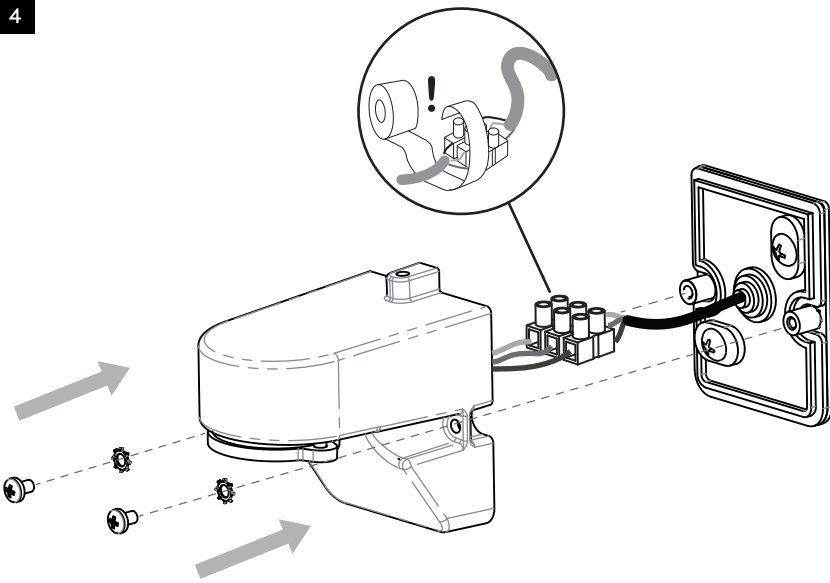

5

